

niftylift

HR15N





Niftylink®



(A) 15.5m
51ft



(B) 13.5m
44ft



(C) 9.7m
32ft



225kg
500lbs



1.5m x 0.8m
4ft 11in x 2ft 8in



150°



180°



(D) 1.99m
6ft 6in



(F) 1.5m
4ft 11in



(H) 4.93m
16ft 2in



(J) 6.4m
21ft



3.5km/h
2.2mph



3.5m
11ft 6in



25%
14°



7250kg
15980lbs

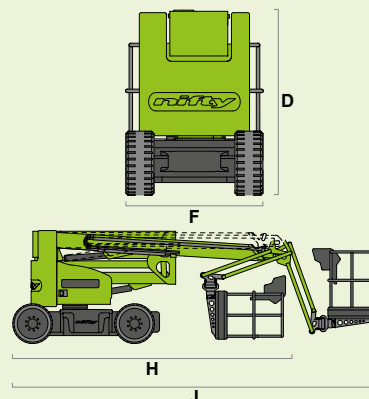
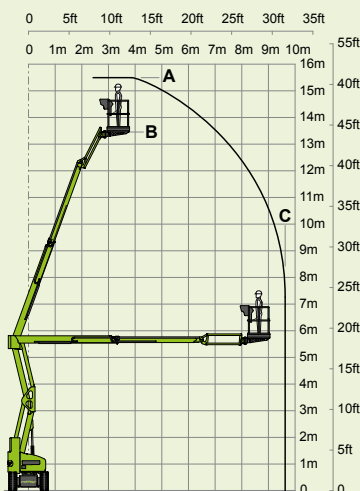

Hybrid²

SiOPS® All-Electric
toughcage Gen² Hybrid
Niftylink®

niftylift

Chalkdell Drive, Shenley Wood,
Milton Keynes, MK5 6GF
England, United Kingdom
+44 1908 223456
sales@niftylift.com
www.niftylift.com

 ISO 9001 QUALITY MANAGEMENT	 ISO 14001 ENVIRONMENTAL MANAGEMENT	 ISO 45001 HEALTH & SAFETY MANAGEMENT
---	--	--

IS-106